

High Performance Door Albany RR355

ASSA ABLOY

ASSA ABLOY Entrance Systems

The global leader in
door opening solutions



Albany RR355

- Combination of leading technology and modern industrial design
- Exceptional wind resistance due to a stable curtain tension system and wind tabs in the side frames
- All-round safety assured by two systems

DOOR DESIGN

The door (side frame, top roll cover and bottom profile) is made from anodised aluminium.

DOOR CURTAIN

Standard: Door is made from clear PVC with blue/red reinforcement stripes.

Optional: Clear PVC with coloured reinforcement stripes or sturdy RollTex® curtain with/without windows.



SAFETY FEATURES

The door has a pre running photocell. A door line photocell also prevents the door closing when objects or people are in the doorway. If the door is not equipped with a knock-out capability, optional an electrical safety contact edge is available.

KNOCK-OUT CAPABILITY

As standard the Albany RR355 is equipped with a knock-out capability. In the event of a collision the bottom profile breaks away, causing a sensor to stop the door. By pushing a button, the door is then closed completely and after then ready for use again. As option the door is available without a knock-out capability.



BOTTOM PROFILE

Bottom profile made from aluminium. In case of an uneven floor, an extended flexible seal is available as option.



ACTUATORS

Individual applications can include additional safety devices. Actuators such as infrared, radar detectors, push buttons, vehicle detector loops or radio transmitters can be added to the control system. Please contact us for additional information for your specific needs.





TOP ROLL COVER

Standard: Delivered without top roll cover

Optional: Top roll cover made from anodized aluminum.



MOTOR COVER

Standard: Delivered without motor cover

Optional: Motor cover is available in plastic RAL 7040.



MOTOR POSITION

Available left or right hand side.

CHAIN DRIVE

As option a chain drive can be used when space at the sides is not available. It is fitted in front of the side frame.

CONTROL BOX

Depending on requirements for opening/closing speed and actuators, two different control systems can be chosen. As Standard the door is equipped with the contactor control system Albany ACS 50.

As Option a frequency converter control system Albany MCC is available. The display unit with foil keys and a graphical display offering easy operation and maintenance is in a small box placed at the side frame or on the wall. (The picture shows the control system Albany MCC.)



High Performance Door Albany RR355

ADVANTAGES OF ALBANY RR355

all-round safety control through:

- pre-running safety photocell and door line photocell for touchless protection of people and goods
- A door line photocell also prevents the door closing when objects or people are in the doorway
- minimising damages at collisions through the self repairing knock-out-capability integrated in the bottom profile
- good wind resistance by curtain tensioning and windbreak tabs in the side frames
- fast opening and closing minimises energy and temperature loss
- alternatively door curtain of clear PVC or of RollTex® Plus

APPLICATION

- as an interior or exterior door between two factory areas
- within fully automated robot operations
- within automated transport systems

DESIGN

The side frames of the door are made from extruded anodised aluminium. The self-supporting side frames must be fixed only on the head- and the base plates on each side. To service the door, the front plate of the side frame can easily be opened or refitted. The bottom profile and the top roll are made from aluminium too. As standard the bottom profile has a knock-out capability.

DOOR CURTAIN

The door curtain is made from clear PVC with silicon free reinforcement stripes. Optional other colours can be chosen. For applications with high mechanical stress alternatively a curtain of RollTex® Plus is available. As standard the door has a tensioning system for extra strength against wind pressure. The edges of the door curtain are reinforced with special wind tabs which are guided in the side frames.

DRIVE UNIT

Gear motor. Position can be chosen right- or left-hand.

CONTROL SYSTEM

Standard Albany ACS 50. Optional innovative frequency converter control system Albany MCC for smooth, dynamic door operation.

KNOCK-OUT CAPABILITY

As standard the door is fitted with a self repairing knock out capability. In the event of a collision, the bottom profile swivels out and a sensor causes the door to stop. If the door does not have a self repairing knock out capability an electrical safety contact edge is available as option instead of a pre-running safety photocell.

MANUAL ACTIVATION

In the event of power failure, the door can be opened by releasing the brake manually. Depending on the width/height ratio, the door opens partially supported by the springs of the counter balance.

SAFETY FEATURES

The door is designed according to the Workplace Directive of the UVV regulations and the harmonized CE Guidelines including the EN 13241-1.

INDICATION OF RISK

The security of the door is designed for normal use and for vehicles in an industrial environment corresponding to the harmonized CE-Guidelines. In consideration of the on site situation – especially in case of pedestrian use – additional safety measures, such as additional actuators may be required. In addition, special environmental conditions may impact the choice of door type. For more information or to schedule an on-site inspection, please contact our sales engineer.

TECHNICAL DATA

Interior door	suitable
Exterior door	suitable
Wind resistance	class 2 - EN 12424
Door dimension (mm) (DW min./max.) (DH min./max.)	1000 / 4000 mm 1500 / 4200 mm
Opening direction	vertical

Surface	
Side frames	aluminium anodised
Bottom profile	aluminium anodised
Top roll	aluminium
Coloured surface of the side frames	•
Covers (option) Top roll cover Motor cover	• ¹⁾ • ¹⁾

Door curtain (alternatively)	
PVC with blue reinforcement stripes	✓
PVC with coloured reinforcement stripes	•
PVC with silicon free reinforcement stripes	•
RollTex® Plus* * optional with windows	• •
Extended seal	•
Wind tabs	✓
Curtain tension	✓
Counterbalance	✓

Drive unit / Control systems	
Drive unit	electrical
Chain drive	•
Albany ACS 50	✓
Albany MCC	•

Safety	
Pre-running safety photocell	✓
Door line photocell	✓
Electrical safety contact edge	•
Fall down protection	✓ tension springs
Knock-out capability	✓
Self opening	✓
Manual activation	✓ with bowden lever operated from the floor
Second bowden lever	•

Speed (m/s)	ACS 50	MCC
Open/close up to max.	1,0/1,0	2,5/1,0
Fuse protection	10 A ⁴⁾	10 A ⁵⁾
Control voltage	24 V DC	24 V DC
Protection	IP 55	IP 55
Motor power kW	1,1 kW	1,1 kW
3L(N)/PE 220/230/380/400/415V; 50 Hz	✓ ²⁾	
3L(N)/PE 380/400/415/440/480V; 50/60 Hz		✓ ³⁾
Additional opening height	–	✓
Potential free contacts max. 250 V	✓	•

Traffic light function	ACS 50	MCC
Without direction detection	✓	✓ 24 V DC
With direction detection	–	✓ 24 V DC
Flashing alarm light	✓	✓ 24 V DC
Error message	✓ LEDs	✓ plain text

- Option
- ✓ Standard
- not available

¹⁾ For doors of height W 2500 mm the use of top roll and motor cover is required according to standard EN 13241-1.

²⁾ Transformer necessary for 440/480/500 V.

³⁾ Transformer necessary for 220/230/500 V.

⁴⁾ 16 A at 220/230

⁵⁾ 10 A preferred, 16 A max.

General Drawing Albany RR355

only with
Albany MCC

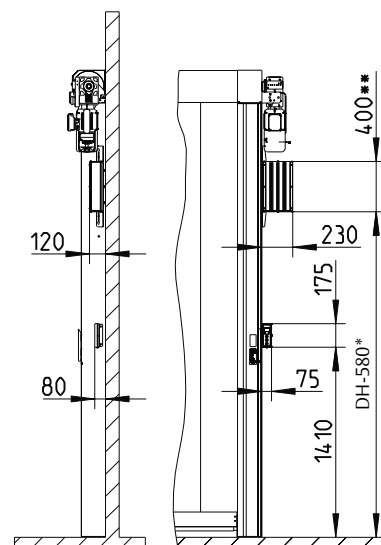
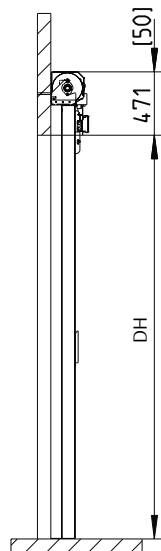
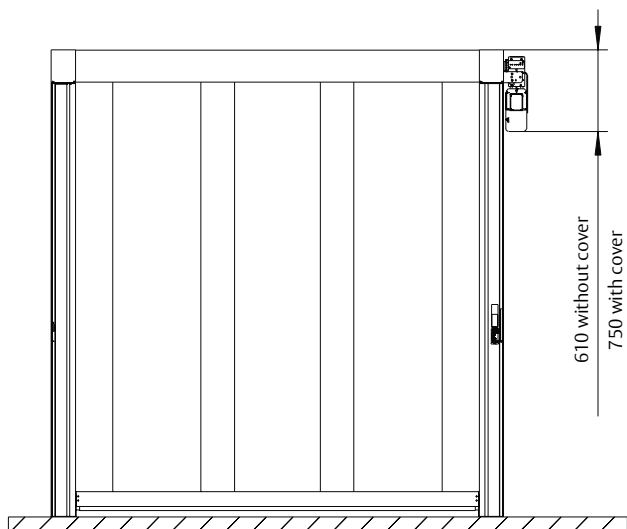

without cover

** 560 / * 740 with extension

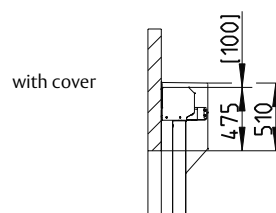
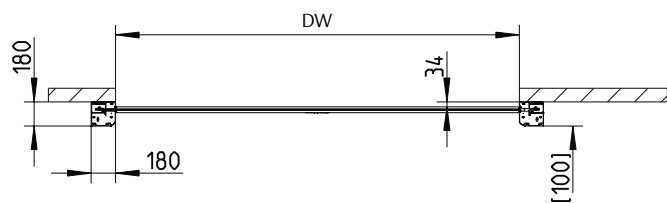
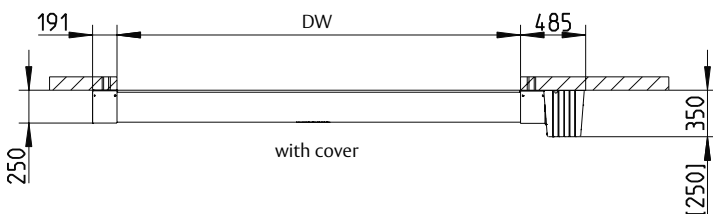
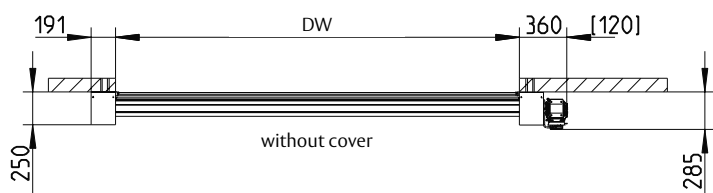

[] = Space needed for installation

Important for crash mechanism: The clear opening between the side columns has to be less or exactly the same as the door width.

Control Unit			
		Albany ACS 50	Albany MCC
Opening speed	max. (m/s)	1,0	2,5
Closing speed	max. (m/s)	1,0	1,0
Dimensions W x H x D	mm	300 x 400 x 210	220 x 380 x 100

Available sizes		
	DW	DH
min. (mm)	1000	1500
max. (mm)	4000	4200

ASSA ABLOY Entrance Systems is a leading supplier of entrance automation solutions for efficient flow of goods and people. With our globally recognized product brands Besam, Crawford, Megadoor and Albany, we offer products and services dedicated to satisfying end-user needs for safe, secure, convenient and sustainable operations.

ASSA ABLOY Entrance Systems is a division within ASSA ABLOY.

ASSA ABLOY

assaabloyentrance.com

Fixing Plan Albany RR355

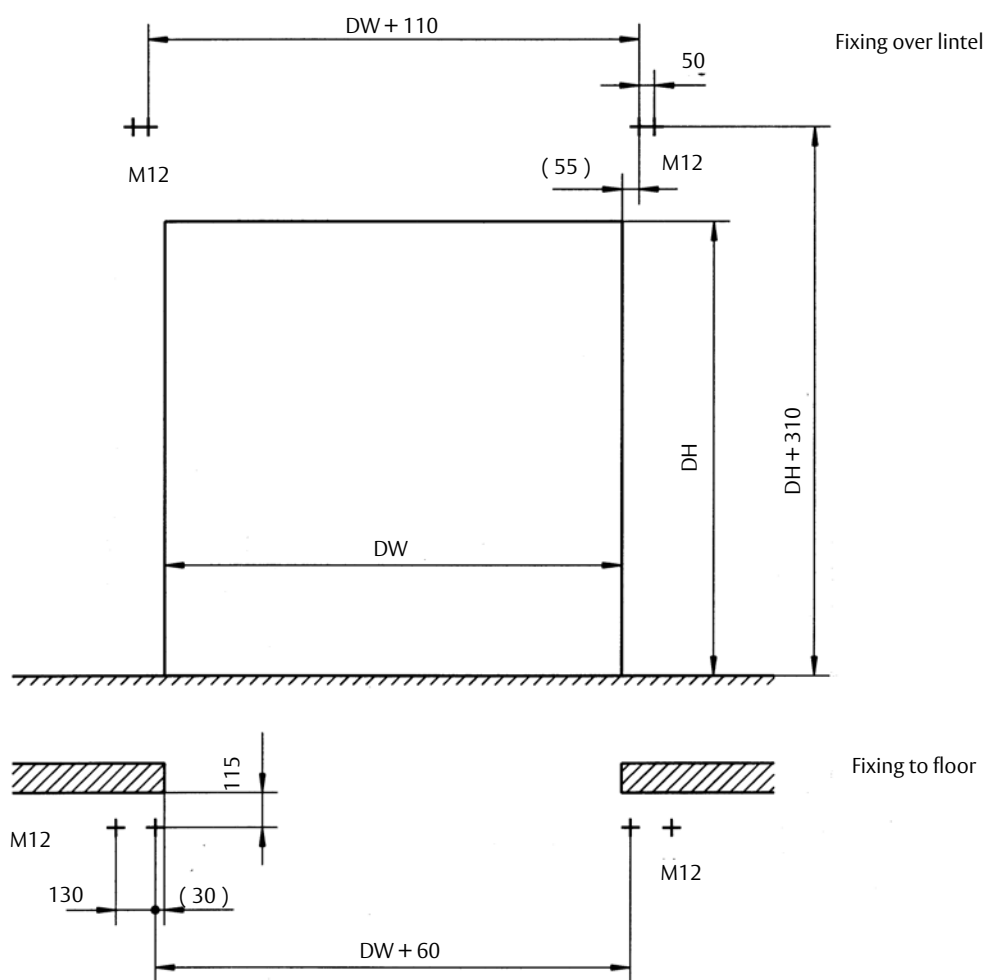

ASSA ABLOY Entrance Systems

info.aaes@assaabloy.com
assaabloyentrance.com

Follow us:



Please enter ASSA ABLOY Entrance in the channel's search field.