

Prinzipzeichnung RapidProtect RP300

General drawing Rapid Protect RP300

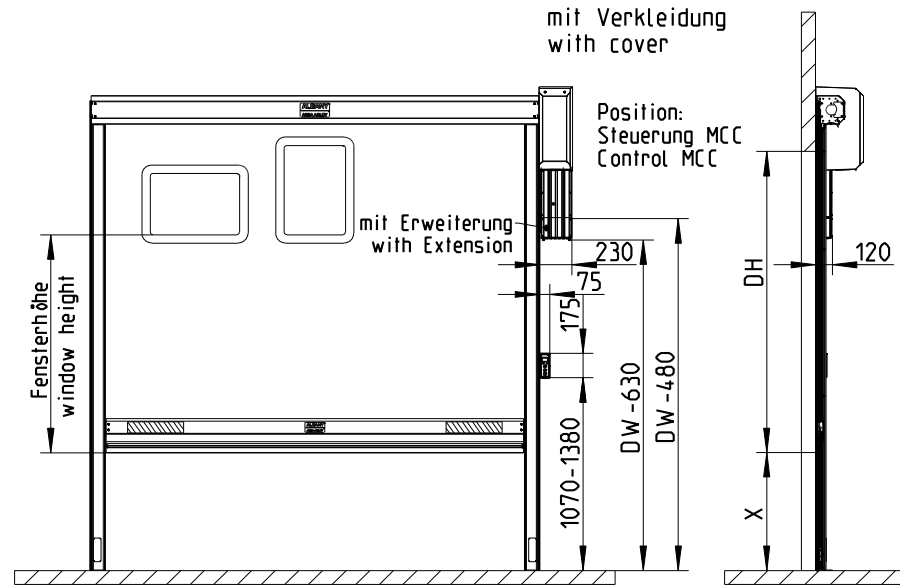

"Option X-Level"
Tor schließt nicht zum Boden, sondern bis auf X-Level
Door does not close to floor, but down to X-level

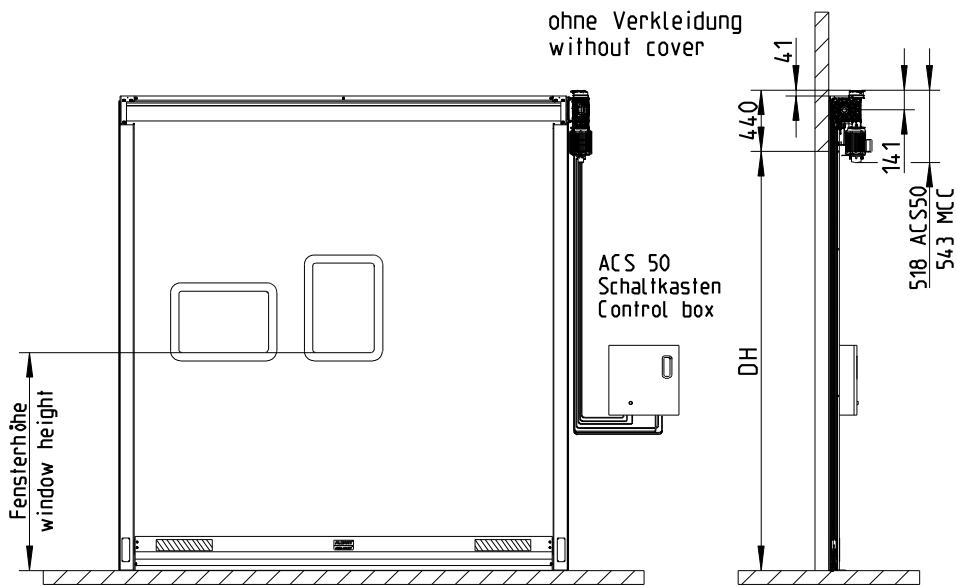
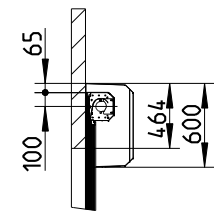
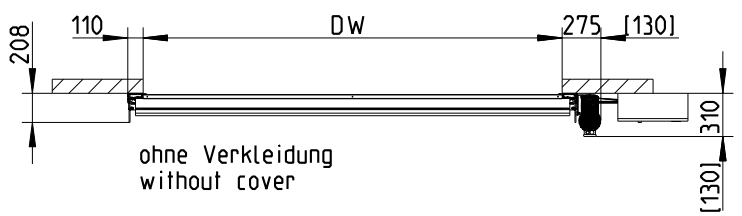

mit Verkleidung
with cover

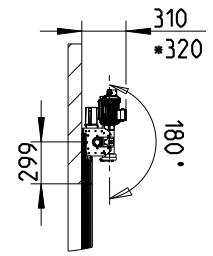
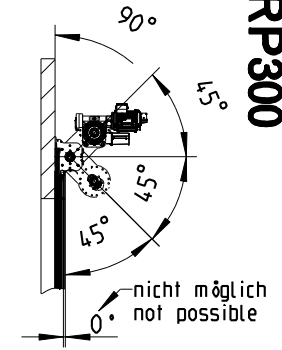
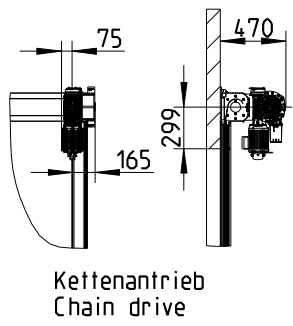
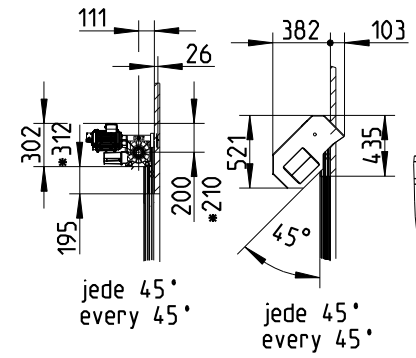
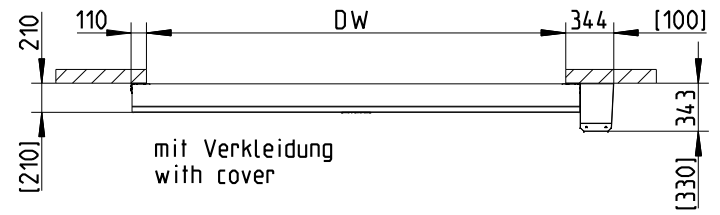

nicht gezeichnete Motor- und Kettenantrieb Positionen auf Anfrage
drive unit- and chain drive position not drawn at request

Toleranz ±3 mm (gültig für alle Maßangaben)
Tolerance ±3 mm (for all dimensions)
Maßangaben in [] ==> Montagefreiraum
Dimensions in [] ==> clearance for installation

*UL-Antrieb
UL-drive unit

9300R0001/b
Stand: 2015-03-18