

# High speed door

## Albany HS9020GHY

ASSA ABLOY

ASSA ABLOY Entrance Systems

The global leader in  
door opening solutions



### Medium sized high speed door for hygienic applications

The Albany HS9020GHY high speed door is designed for interior applications in humid or corrosive environments, and in the food industry where hygiene demands are high. The main features of the Albany HS9020GHY are:

- Medium-sized, max. 4000 x 4000 mm
- Humid or Corrosive environments
- Inside usage
- Stainless steel 304 construction
- Gravity drive system
- Opening speed up to 1,2 m/s (Option: 2,0 m/s)

The Albany HS9020GHY offers a very good sealing thanks to a unique design. It requires very little space and protects your environment against drafts, humidity, dust and dirt.

Exceptional reliability and smooth operation is ensured by a motor driven by a frequency inverter. This technology ensures a soft start and stop.

The robust steel, IP54 classified, control box is easy to operate and to program. The mechanical main switch and emergency stop make it foolproof. The clear display gives a wide range of information like an easy to read cycle counter.

#### Break-away - and Automatic Repair system

Albany high speed doors are equipped with a break-away - and automatic repair system. The curtain reintroduces itself after a crash to reduce downtime and maintenance.

#### Completely safe

Features that make our doors completely safe.

- The soft bottom edge has no rigid parts, it moulds around any obstruction to prevent injury or damage.
- When an object hits the door, the fabric curtain absorbs the impact and releases itself from its side guides without causing damage or being damaged itself.

#### Windows and vision panels

To increase the admission of daylight and visibility, the door curtain can be equipped with windows or vision panels. Windows have fixed sizes and are located on a pre-defined grid. A vision panel is always located on the full width of the door curtain.

### Technical Data

Min size (W x H)	1000 x 2000 mm
Max size (W x H) <sup>1)</sup>	4000 x 4000 mm
Operating speed	opening: up to 1,2 m/s <sup>2</sup> closing: 0,5 m/s
Wind load resistance, EN 12424	class 1 (300 N/m <sup>2</sup> ) maximum wind load while closing 50 N/m <sup>2</sup>
Water penetration, EN 12425	class 2 (50 N/m <sup>2</sup> )
Air permeability, EN 12426	class 1 (24 m <sup>3</sup> /m <sup>2</sup> /h at 50 Pa)
Thermal transmittance	6,02 W/ (m <sup>2</sup> K)
Lifetime expectations	1.000.000 cycles

1) Other sizes available on request 2) Depending on door size

# Dimensional specifications

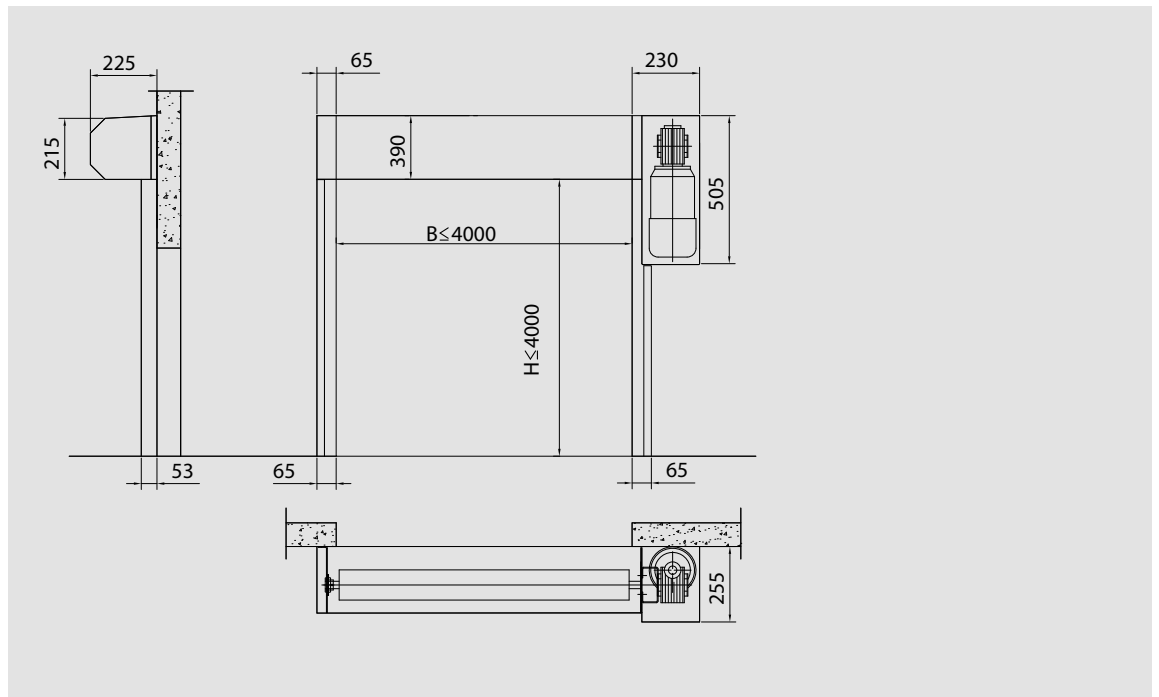



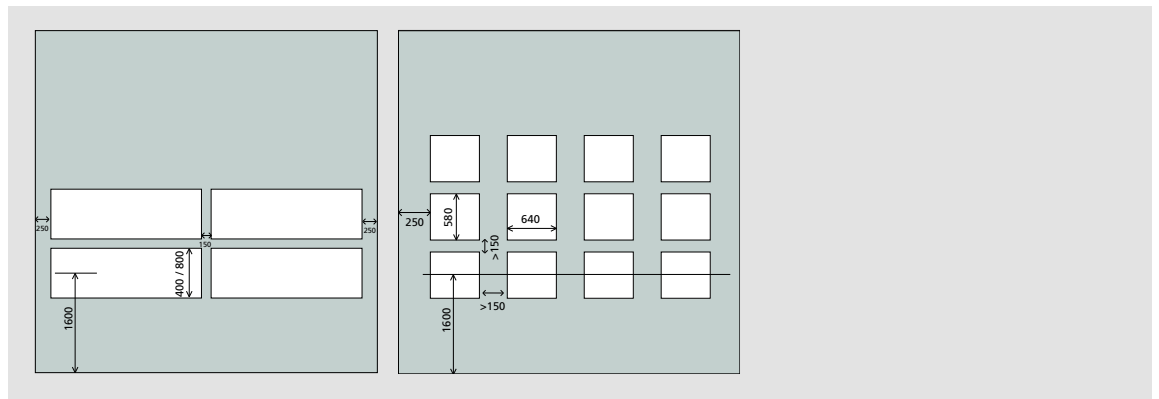



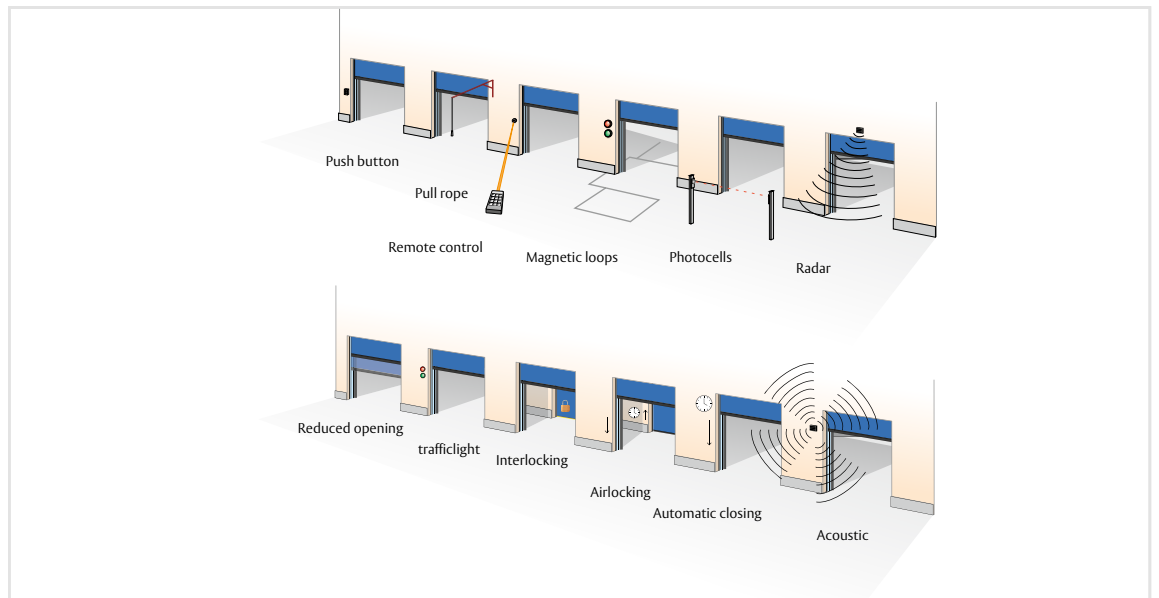

# Windows and Vision panels



# Options access and automation



# Standard available colours

 Signal yellow RAL 1003	 Flame red RAL 3000	 Moss green RAL 6005	 Jet black RAL 9005	 On request Other colours
 Pure orange RAL 2004	 Ultramarine blue RAL 5002	 Light grey RAL 7035	 White RAL 9010	